



B. D. INDUSTRIES (PUNE) LIMITED

(FORMERLY KNOWN AS B. D. INDUSTRIES (PUNE) PRIVATE LIMITED)

Tel: +91 (22) 6249 0801 **E-mail:** marketing@bdi-group.org **Website:** www.bdi-group.org

CIN NO. L25203MH2010PLC202092, Certified for ISO 9001: 2015, ISO 14001: 2015, ISO 45001: 2018

Registered Office: 1501-B, Universal Majestic, PL Lokhande Marg, G M Link Road, Govandi West, Chembur, Mumbai - 400043

May 27, 2026

To,
General Manager, Listing Department
BSE Limited
Phiroze Jeejeebhoy Towers,
Dalal Street,
Mumbai - 400001

Scrip Code: 544468

Dear Sir,

Sub : Investor Presentation Investor Presentation – Half Year & Year Ended March 31, 2026

Pursuant to Regulation 30 of the SEBI (Listing Obligations and Disclosure Requirements) Regulations, 2015, please find enclosed the Investor Presentation on the performance of the Company for the Half Year & Year Ended March 31, 2026.

This update shall also be available on the website of the Company.

This is for your information and records.

Yours sincerely,
Thanking you,

For **B. D. INDUSTRIES (PUNE) LIMITED**

Prerana Gor
Membership No: F7215
Company Secretary & Compliance Officer

Encl: As above



Durable plastic solutions for tomorrow

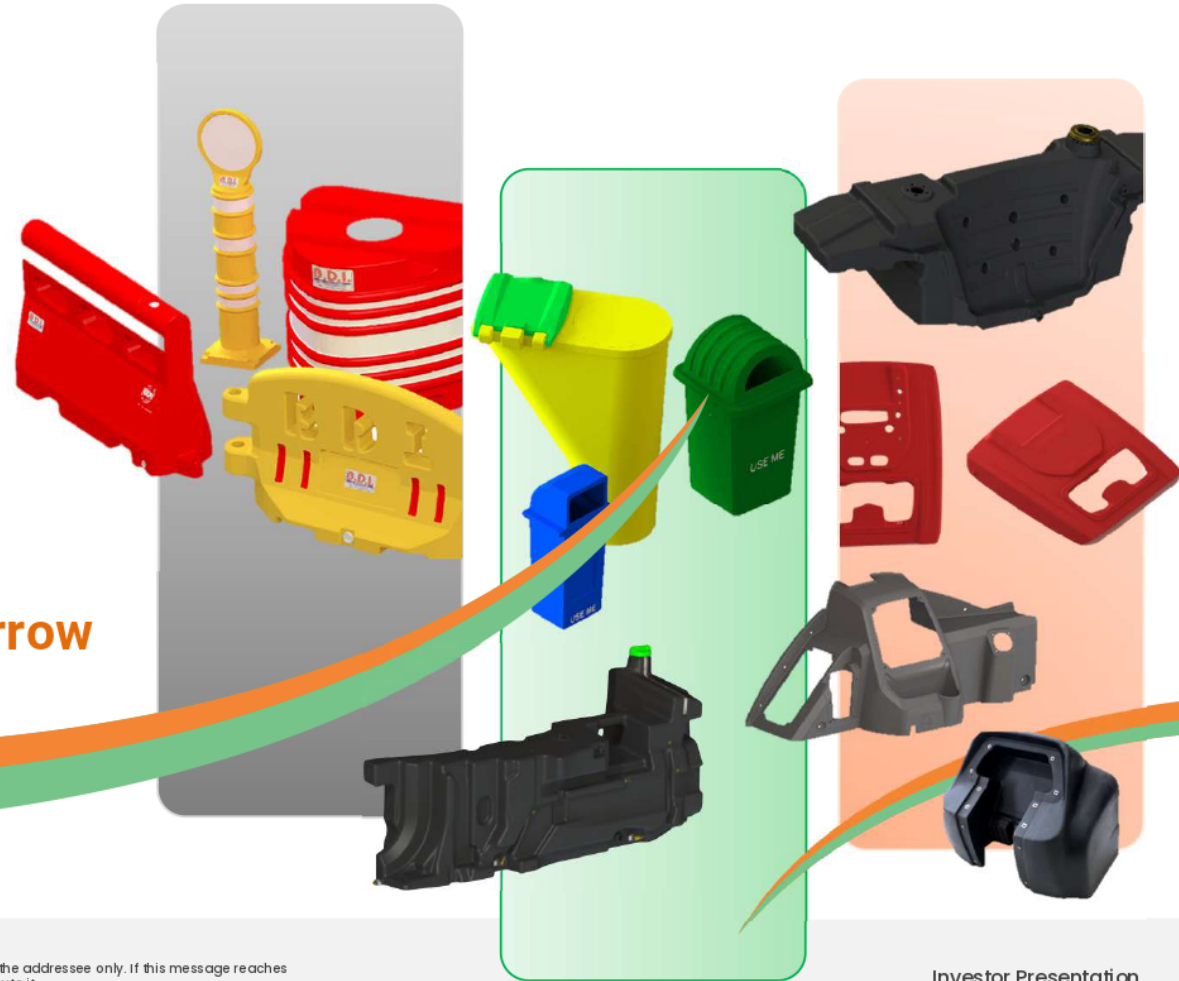

This communication being sent by the offices of BDI Group and is privileged, confidential and is directed to and for the use of the addressee only. If this message reaches anyone other than the intended recipient, we request the reader not to reproduce, copy, disseminate, or in any manner distribute it.

Investor Presentation

Contents

Company and Financial Overview	03-04
Our Presence across the country	05-06
Capacity Utilization	07
Zaheerabad Plant Progress	08
Renewable Energy	09
Our Achievements	10
Product Profile	11-16
Our Customers and Partners	17
Key Milestones	18
Plant and Machinery	19
Manufacturing Process	20
Management Team	21
Shareholding Structure	22



Company Overview



1984 Year BDI Group was founded

2006 Started automotive business (OEM)

4 Manufacturing units strategically located across India

400+ Workforce

550+ Products



Core Competencies

Plastic fuel tanks, urea tanks, hydraulic tanks, air ducts, pallets, crates, barricades, and traffic cones

Experience

35 + years of experience in developing, manufacturing, and supplying rotationally-moulded plastic products

Clientele

Products cater to diverse industries and cater to multiple industries like Automotive, Road Safety, Material Handling etc.

Manufacturing Plants

Pune facility is with B. D. Industries (Pune) Limited and rest three facilities (including one under construction) are with our wholly owned subsidiary B.D. Industries (India) Private Limited

Company Overview



We are a market leader in rotational molding with over 35 years of expertise. Renowned for innovative, sustainable products, We serve over 200+ customer-partners, setting industry benchmarks in design, manufacturing, and customer-centric solutions.

Market leader with **2+ million OEM units** supplied.



50+ registered designs



1000+ Customer-Partners



550+ Production Part Numbers



35+ Years of Rotomolding Experience

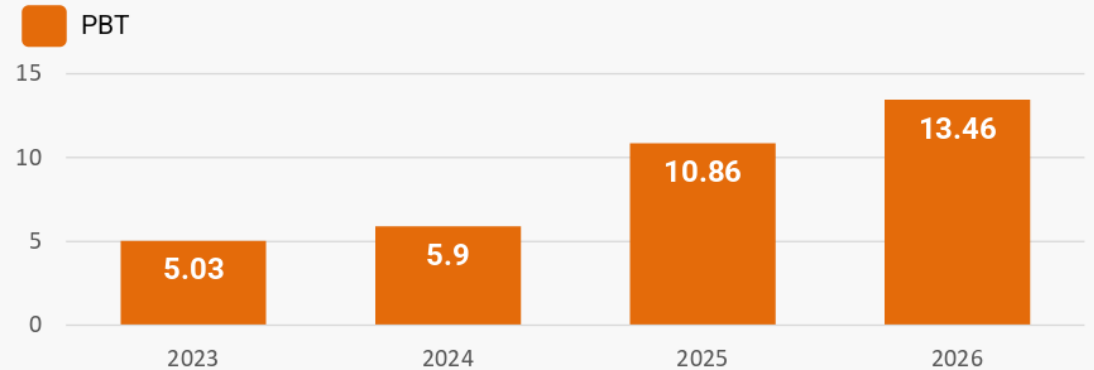
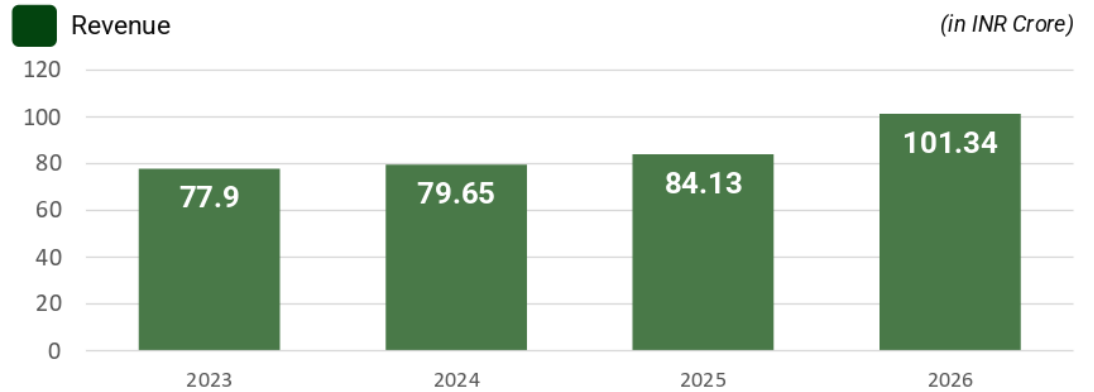

Consolidated Financials - B.D. Industries (Pune) Limited



B.D. Industries (Pune) Limited | Consolidated | ₹ in Crores | H1 = Apr-Sep 2025 | H2 = Oct 2025-Mar 2026 | FY = Full Year

Revenue Trend (₹ Crores)

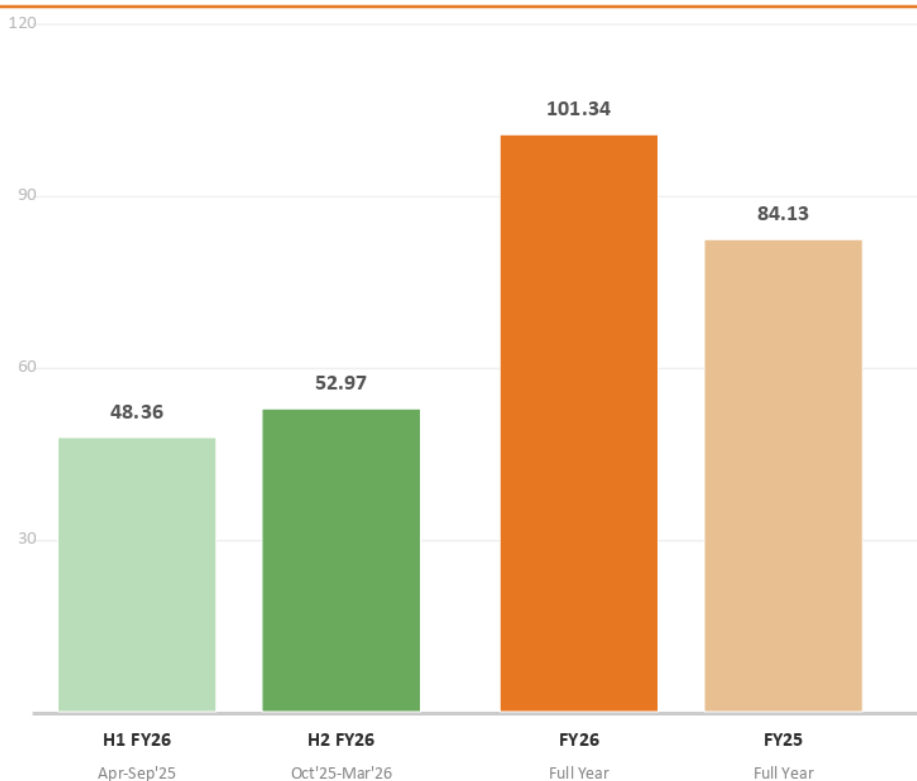

Growth Analysis | FY25 → FY26

Revenue			▲ +20.45%
FY25	84.13	→	FY26
			101.34
			+17.21 Cr
EBITDA			▲ +17.5%
FY25	15.27	→	FY26
			17.95
			+2.68 Cr
PBT			▲ +23.9%
FY25	10.86	→	FY26
			13.46
			+2.60 Cr
PAT			▲ +16.3%
FY25	8.22	→	FY26
			9.56
			+1.34 Cr

Margin Analysis (FY26)

Gross Margin	EBITDA Margin	PBT Margin	PAT Margin
46.5%	17.8%	13.4%	9.5%

Standalone Financials - B.D. Industries (Pune) Limited



B.D. Industries (Pune) Limited | Standalone | ₹ in Crores | H1 = Apr-Sep 2025 | H2 = Oct 2025-Mar 2026 | FY = Full Year

Revenue Trend (₹ Crores)

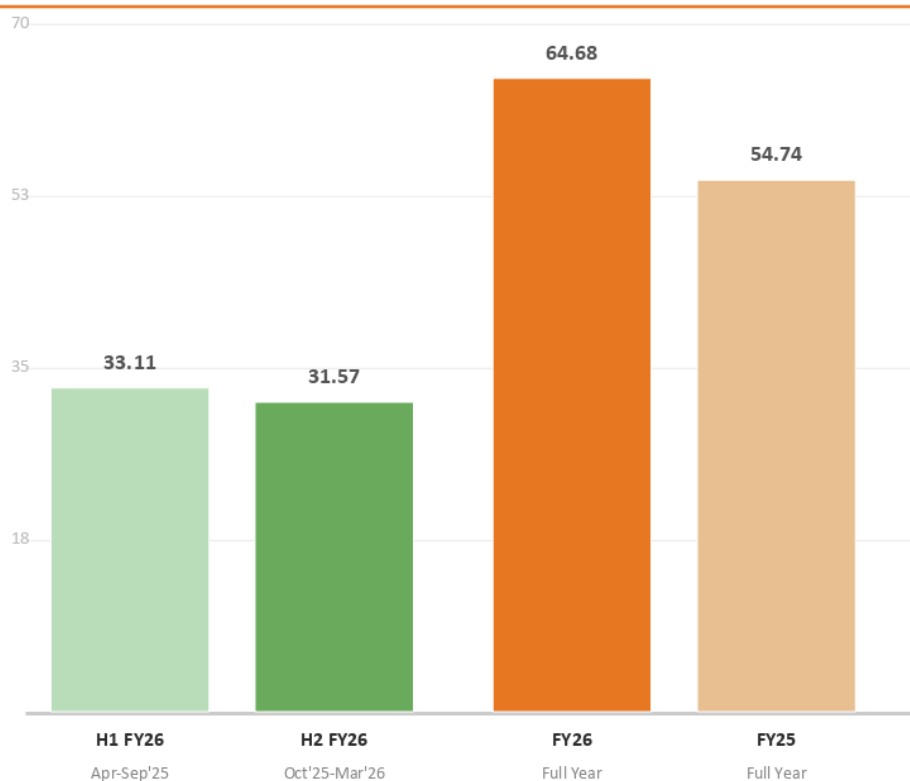

Growth Analysis | FY25 → FY26

Revenue			▲ +18.1%
FY25	54.74	→	FY26
			64.68
			+9.93 Cr
EBITDA			▲ +26.2%
FY25	8.57	→	FY26
			10.81
			+2.25 Cr
PBT			▲ +36.6%
FY25	6.85	→	FY26
			9.36
			+2.51 Cr
PAT			▲ +26.7%
FY25	5.34	→	FY26
			6.77
			+1.42 Cr

Margin Analysis (FY26)

Gross Margin	EBITDA Margin	PBT Margin	PAT Margin
39.6%	16.8%	14.5%	10.5%

Our Presence across the country

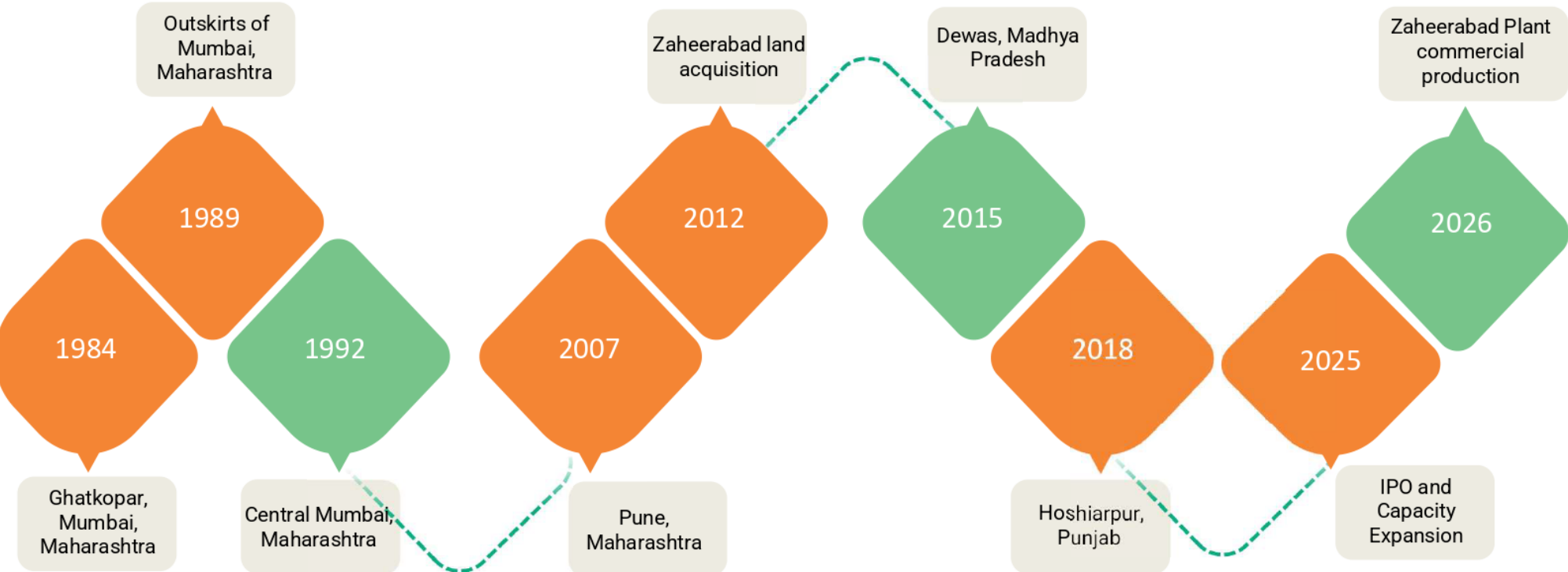

Our Presence across the country

Pune Plant

Owned by B. D. Industries (Pune) Private Limited

📍 Gate No. 999, Sanadwadi, Tal. Shirur, Dist. Pune, Maharashtra

Dewas Plant

Owned by B D Industries (India) Private Limited

📍 Plot No. 36B, Industrial Area No-1, A.B Road, Dewas, Madhya Pradesh

Hoshiarpur Plant

Owned by B D Industries (India) Private Limited

📍 Village Dhehan, Post Office Mandiala, Hoshiarpur Land, Punjab

Zaheerabad Plant

Owned by B D Industries (India) Private Limited

📍 Plot No. 66/A, situated at Industrial Park, Buchinelly, Zaheerabad Mandal, Medak District, Telangana

Corporate Office

📍 15th Floor, Universal Majestic (Mighty), Chembur West, Mumbai, Maharashtra



Capacity Utilization



Pune Plant

2008

Year of Launch

2 acres

Size of the Plot

**60% of the
plot size**

Size of the building

5

Number of Machines

1800 MT p.a.

Installed Capacity

1399 MT p.a.

Utilized Capacity



Dewas Plant

2015

Year of Launch

3.5 acres

Size of the Plot

30%

of the plot size

Size of the building

2

Number of Machines

1500 MT p.a.

Installed Capacity

963 MT p.a.

Utilized Capacity



Hoshiarpur Plant

2022

Year of Launch

2 acres

Size of the Plot

40%

of the plot size

Size of the building

2

Number of Machines

1200 MT p.a.

Installed Capacity

613 MT p.a.

Utilized Capacity

Zaheerabad Plant Progress

Plot No. 66/A, Industrial Park, Buchinelly, Zaheerabad Mandal, Medak District, Telangana - 502228



1.5 acres

Size of plot

750 MT

Proposed installed capacity

2026

Proposed year of launch



Renewable Energy

Patented Product Portfolio

- BDI has developed patented rotomoulded components purpose-built for solar and wind energy applications



Strategic Growth Vertical

- Aligned with India's National Solar Mission and renewable energy expansion targets
- Lightweight, durable, corrosion-resistant plastic components offer a cost-effective alternative to metal in renewable energy infrastructure

New order received in renewable space

Counterparty	Domestic Entity
Nature of Contract	Supply of Spacer
Estimated Value	₹10.08 Crore (Including Tax)
BSE Intimation Date	2nd April 2026

Our Achievements



Certifications

BDI Group of Companies are audited and certified



ISO 9001 : 2015, ISO 14001 : 2015 & ISO 45001 : 2018

D&B Rating

1A

2

Our Product Portfolio



Automotive Division

Fuel tanks, urea tanks, hydraulic tanks, roof tops, fenders.

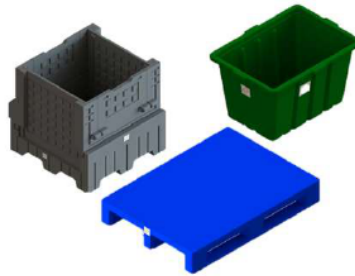

Material Handling Division

Lightweight, corrosion-resistant plastic components, including pallets and crates.



Highway and Traffic Safety

Sustainable and recyclable rotomolded parts like barricades and traffic cones.

Business Verticals

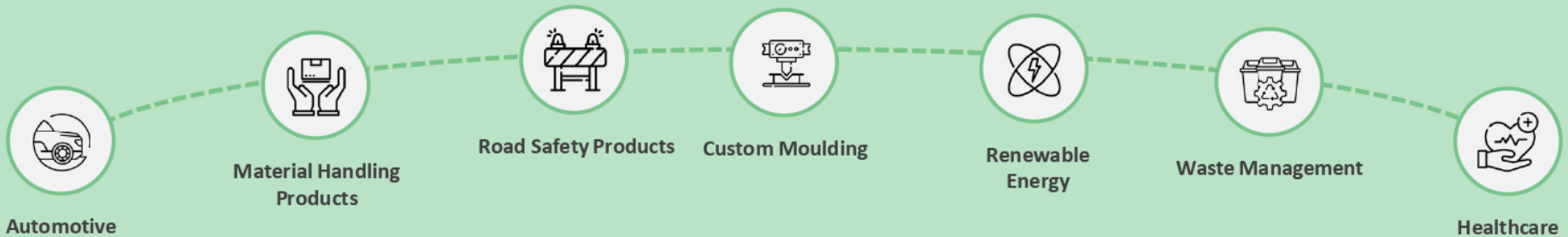

Products for Tractors

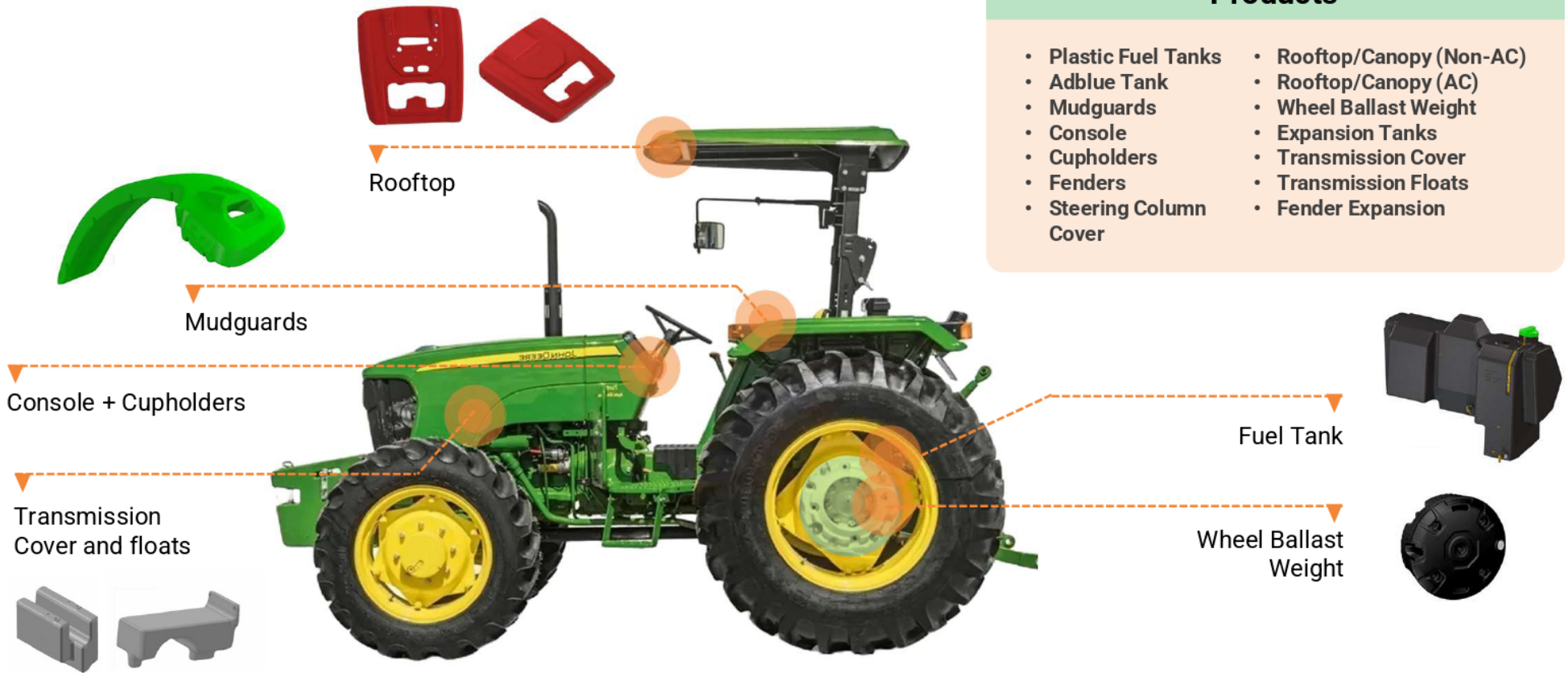

Automotive Products

For Trucks



- Plastic Fuel Tanks
- Adblue Tank
- Mudguards
- Hydraulic Tank for Tippers
- Battery Boxes
- Tool boxes
- Snorkels
- Fenders
- Mirror Covers (ORVM)
- Wind Deflectors

For Buses



- Plastic Fuel Tanks
- Adblue Tank
- Mudguards
- Battery Boxes
- Tool Boxes
- Mirror Covers (ORVM)
- Bus Seats
- Internal Engine Cover
- Door Panels (Inside)
- Fenders

Automotive Products

For Construction Equipment



- Plastic Fuel Tanks
- Mudguards
- Console
- Cupholders
- Fenders
- Steering Column Cover
- Rooftop/Canopy (Non-AC)
- Rooftop/Canopy (AC)
- Wheel Ballast Weight
- Expansion Tanks
- Transmission Cover
- Transmission Floats

For 3-Wheeler



- Plastic Fuel Tanks
- Adblue Tank
- Rooftop/Canopy
- Bench Seats
- Half Doors
- Full Doors
- Pickup Load Body
- Tipper Body
- Steering Column Cover

Other Products

Material Handling



- Plastic Pallets (Steel reinforced, non-PUF) Plastic Pallets (Steel reinforced, PUF)
- Containers with pallet base
- Foldable containers (re-use)
- Collapsible Pallets
- Vending Carts
- Transmission and Engine Skids
- Returnable packaging (to- and fro-shipments)
- Crates
- Textile Pallets
- Chemical Tanks (also for storage & dispensing of Adblue/ DEF)

Solar and Renewable Energy

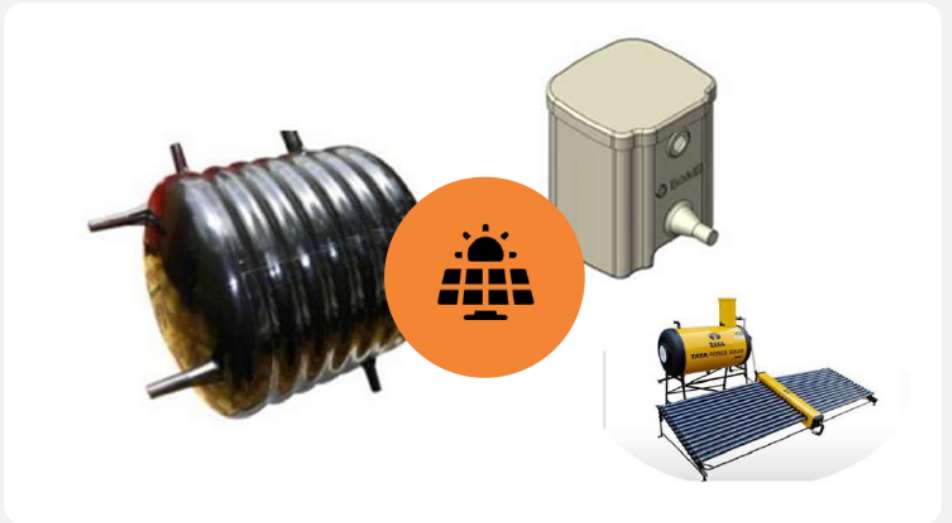

- PUF Insulation
- Inner Tank
- Outer shell
- Grommet
- Float Tank SWHS
- Plastic Manifold

Other Products



DG & ancillary equipment

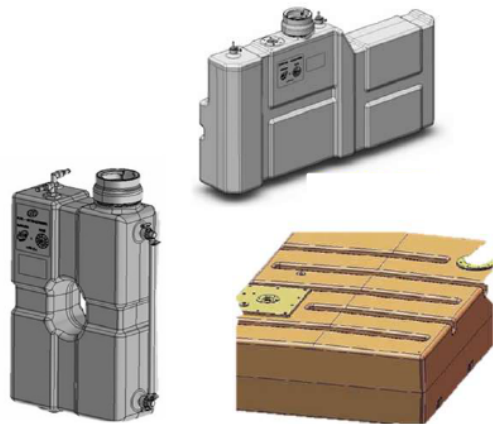

- Plastic Fuel tank
- Canopy Shell
- Air Ducts
- Body vents
- Access doors (Insulated)
- Radiator Cowls
- Auxiliary tank

Road Safety Products



- Metro Rail barricade
- Safety Fence
- 3 piece (detachable) barricades
- Parabolic barriers
- 2 meter/ 1 meter barricades
- New jersey barricades
- Light barriers
- Traffic cones
- Delineators
- Bollards
- Un-mountable kerbs
- Lane dividers
- Speed breakers
- Road studs/ cat eyes

Agri Machinery



- Sprayer Tank
- Chemical Tank
- Water Tank
- Corn Harvester Head
- Plastic Roofs
- Body panels and covers

Our Customers & Partners

<p>John Deere 20+ yrs Tractors & CE</p>	<p>Mahindra & Mahindra mahindra^{Rise} 20+ yrs Tractors & CV</p>	<p>JCB (UK) JCB 15+ yrs Construction Equip.</p>	<p>Tata Power TATA POWER 10+ yrs Solar Energy</p>
<p>Kubota Kubota 8+ yrs Tractors</p>	<p>Escorts ESCORTS 8+ yrs Tractors</p>	<p>Sonalika SONALIKA 8+ yrs Tractors</p>	<p>Franklin Franklin 2+ yrs Others</p>

Also Serving: Bharat Benz | Tata Motors (MoU) | Swaraj | Mahindra Electric | Mahindra Truck & Bus | CNH Industrial | Yanmar | Fleetguard | Godrej Interio | Preet | VST | L&T | Sandhar | Gardner Denver | Bosch | Ingersoll Rand | Kirloskar | Fritzmeier Cabs | TAFE | Tata Hitachi | Bajaj | Shaktiman | And many more...



Key milestones

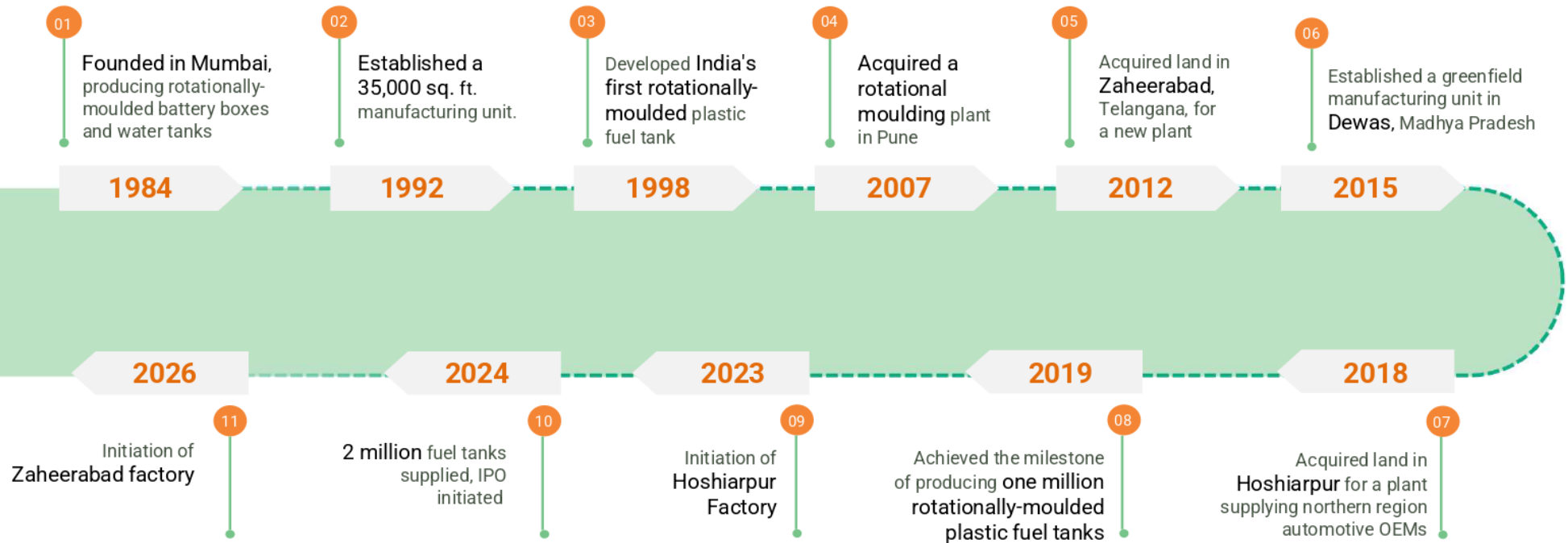

Plant and machinery

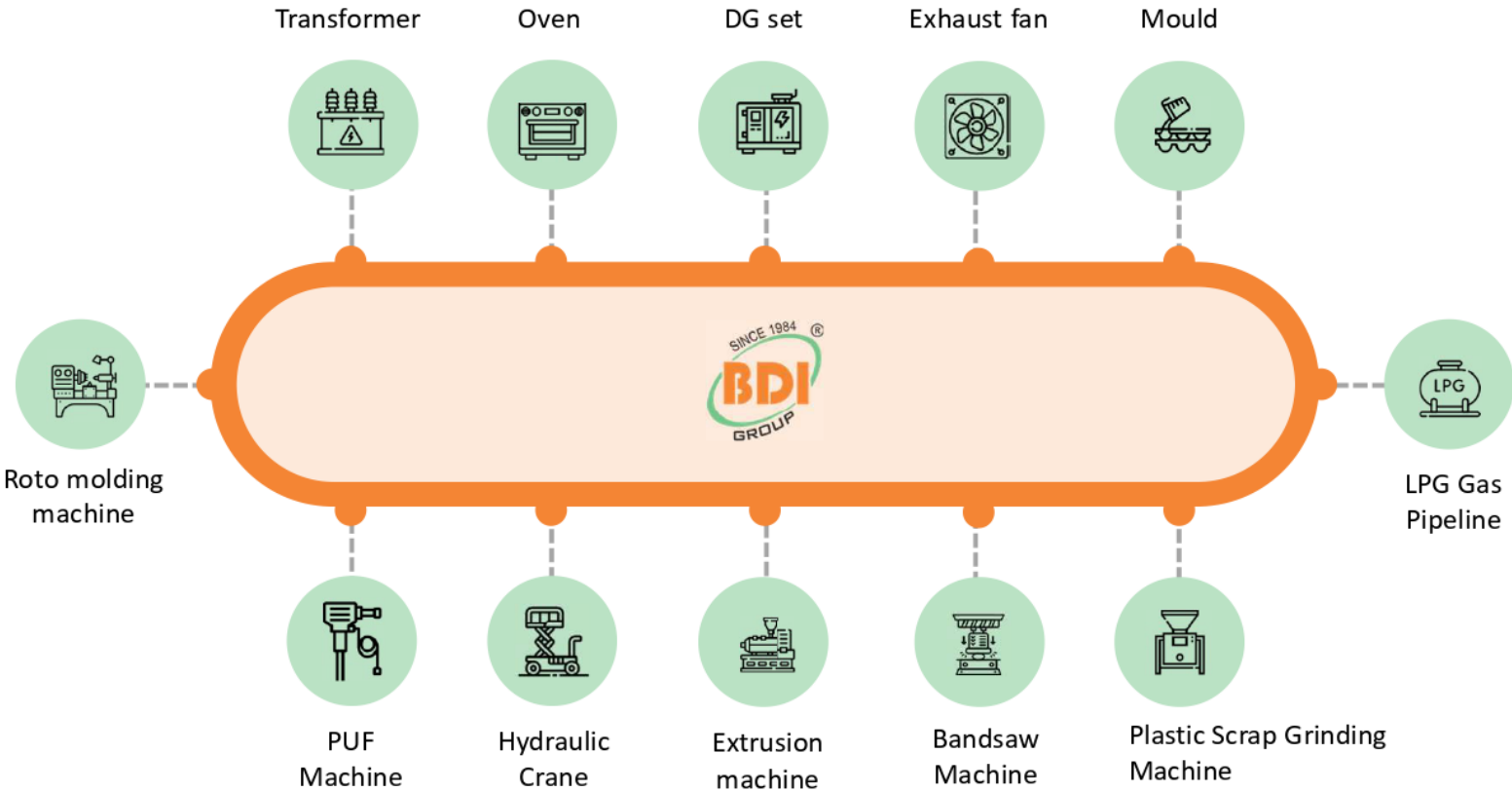

End-to-End Manufacturing Process Workflow

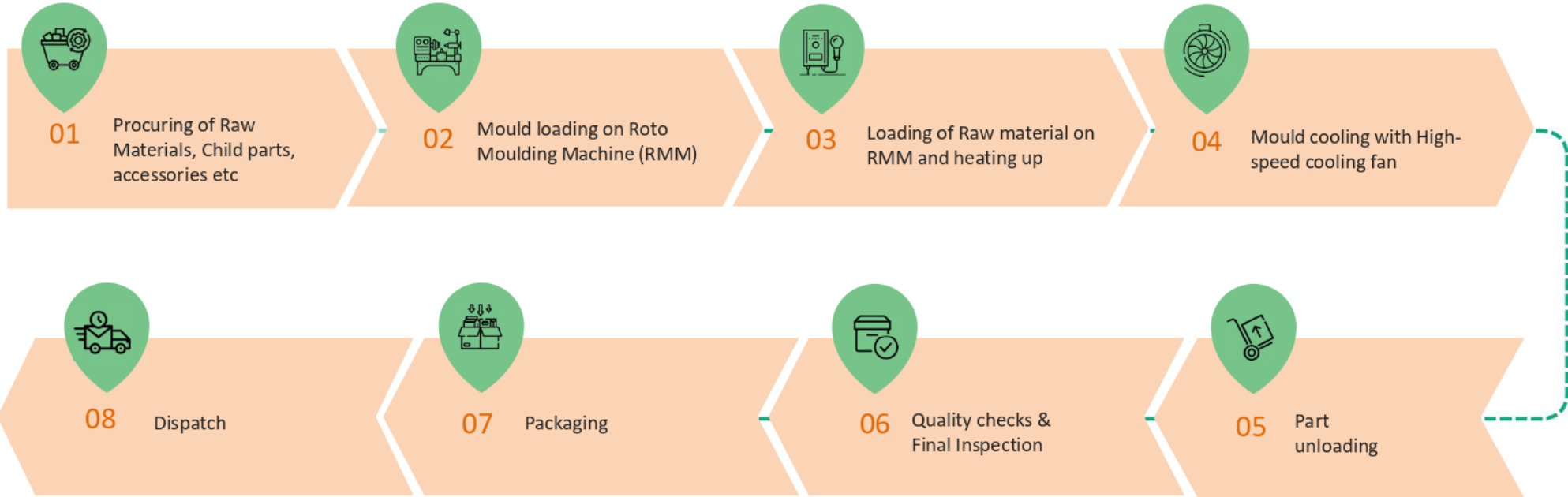

Management Team



Dalbirpal Saini

Chairman & Managing Director

A technical maestro with 40+ years of experience



Akshay Saini

Director

MBA (SP Jain), spearheading sales and innovation



Rahul Saini

Director

Finance expert with expertise in SAP ERP integration



Sanjay Patil

Director

25+ years of experience in Rotomoulding Industry, 7 years In BDI



Arti Saini

Director

Pivotal in fostering and maintaining strong stakeholder relationships.

KMP



Swapnil Bhosale
VP-OEM

15+ years experience
8+ years In BDI



A.V.D.V Prasad Rao
VP-MHE and RSP

15+ years experience
6+ years In BDI



Ashwini Sharma
VP-Design

15+ years of experience in design
8+ years In BDI



Prerana Gor
CS

15+ years of experience



Pranshu Garg
CFO-CA

9 years of experience

Plant heads



Sagar Gaikwad
Plant Head - Pune

10+ years experience
1 year In BDI



Anup Dubey
Plant Head - Dewas

15+ years experience
13 years In BDI



Avijit Mondal
Plant Head - Hoshiarpur

10+ years experience
1 year In BDI

Shareholding Pattern: Post-IPO structure

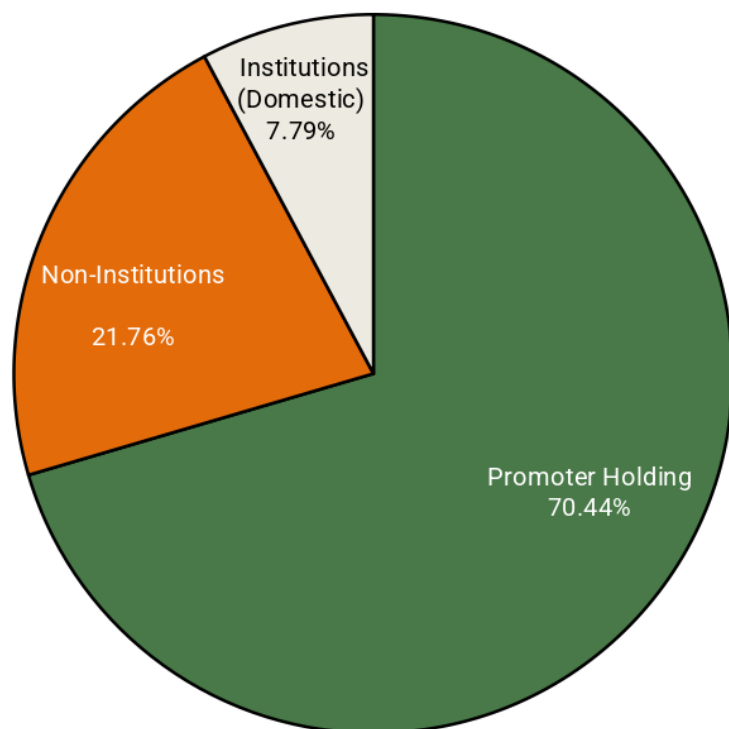

Promoter Holding

70.44%

Non-Institutions

21.76%

Institutions (Domestic)
Including Market Maker

7.79%

Thank you!



**Durable plastic
solutions for
tomorrow**



Corporate Office:

BDI Group 15th Floor, Universal Majestic (Mighty), Off Ghatkopar Mankhurd Link Road, Opp. RBK International School, Chembur West, Mumbai 400043, Maharashtra, India.



Phone:

+91-22-6249-0801/02



Email:

marketing@bdi-group.org



Website:

www.bdi-group.org